

MM-405

2MP High Resolution 40x Zoom Module

LVDS CVBS



Features

- 1/2.8" 2MP Sony CMOS Sensor
- 1080p 60fps/30fps, 720p 60fps/30fps
- 40x Optical Zoom(4.25mm~170mm) & 32x Digital Zoom
- Day & Night(ICR)
- Wide Dynamic Range
- Digital Noise Reduction(2D+3D)
- Digital Image Stabilization
- Privacy Mask Function
- High Light Compensation
- Intelligent Motion Detection
- Defog Function
- Supports VISCA, Pelco-D/P Protocol
- Video Out : LVDS, CVBS

Field of View

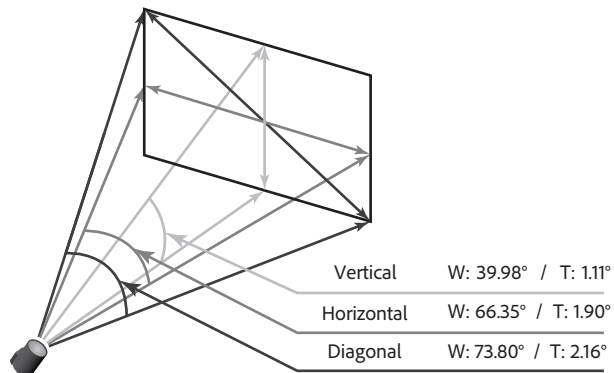

Dimensions

Unit : mm

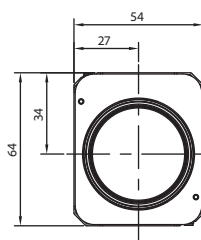

FRONT

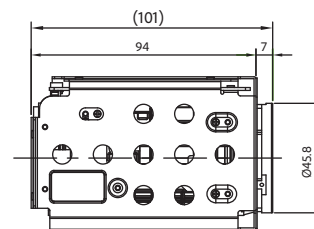

LEFT

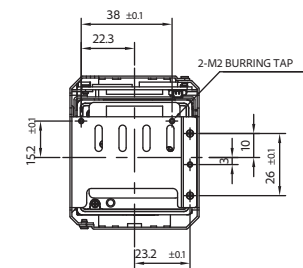

BACK

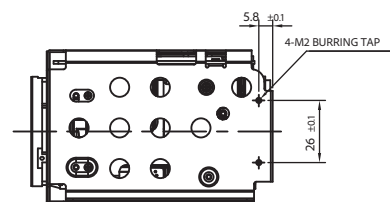

RIGHT

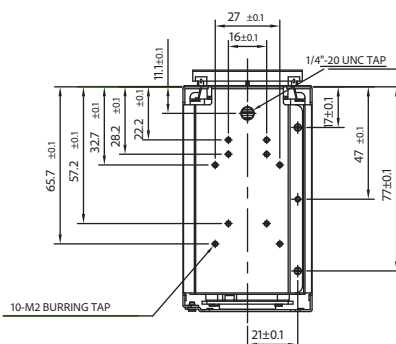

BOTTOM

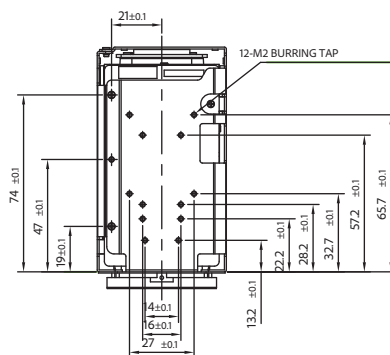

TOP

Specifications

MM-405				
Image Sensor	1/2.8" Sony CMOS Sensor			
Total Pixels	1,945 (H) x 1,109 (V) = 2.16M Pixels			
Active Pixels	1,937 (H) x 1,097 (V) = 2.12M Pixels			
Scanning System	Progressive Scan			
Sync. System	Internal			
Resolution	Digital : 1080p 60(50)/30(25)fps, 720p 60(50)/30(25)fps			
	Analog : CVBS			
Min. Illumination	Color(1/30s, 79.5dB) : 0.01 lux , BW(1/30s, 79.5dB) : 0.002 lux			
	Color DSS(1/1s, 79.5dB) : 0.001 lux , BW DSS(1/1s, 79.5dB) : 0.0002 lux			
Video Output	Digital : LVDS			
	Analog : CVBS			
S/N Ratio	more than 50dB (AGC off)			
Lens Type	40x Day & Night Zoom Lens			
Zoom Ratio	Optical 40x, Digital 32x Zoom			
Focal Length	f = 4.25 mm ~ 170 mm			
Aperture Ratio	F1.6 (wide) ~ F4.95 (tele)			
Angle Of View(D, H, V)	Wide	73.80°	66.35°	39.98°
	Tele	2.16°	1.90°	1.11°
AF Mode	Auto / One Push / Manual			
Min. Distance	0.1 / 1.5 / 3.0 / 5.0 / 10.0 m			
Lens Refresh	One Push / 1 ~ 10Days			
Digital Zoom	Off / MAX 2x ~ 32x			
Exposure	Auto / Iris.P / Shut.P / Manual			
Gain Control(AGC)	0 ~ 10 steps			
Shutter Speed	1/1 ~ 1/30,000 sec			
Iris	Close ~ F1.6			
Digital Slow Shutter(DSS)	Off / x2 / x4 / x8 / x16 / x32 (/ x64 : 60 or 50 fps mode only)			
Flickerless	Off / On / Auto			
Brightness	0 ~ 14 steps			
Back Light	Off / BLC / HLC / WDR			
Day&Night	Auto / Day / Night / Ext-in			
White Balance	Auto / One Push / Manual / Indoor / Outdoor / Auto-Ext			
DNR	2D/3D, 2D+3D			
Mirror	Off / H / V / H&V			
Sharpness	0 ~ 15 steps			
DWDR	Off / Manual / Auto			
Defog	Off / Manual / Auto			
Privacy Mask	Off / On (8 points)			
Motion Detection	Off / On (4 points)			
Defect Detection	Off / On			
System	NTSC / PAL			
Communication	Baud Rate : 2400 / 4800 / 9600 / 19200 / 38400 / 57600 / 115200			
	Protocol : VISCA / Pelco-D / Pelco-P			
Power Source	9V to 15V DC			
Power Consumption	Max 530mA			
Power Input	Connector			
Video Output	Connector			
Storage Temperature	-20 °C ~ +60 °C (Humidity : 0%RH ~ 90%RH)			
Operating Temperature	-10 °C ~ +50 °C (Humidity : 0%RH ~ 90%RH)			
Dimensions	54(W) x 64(H) x 101(D)			
Weight	355g			

* Design and specifications are subject to change without notice.

Pin Assignment

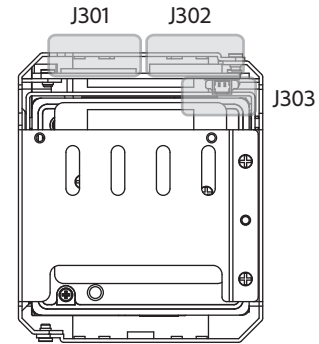

J301	
1	TXOUT3+
2	TXOUT3-
3	TXCLKOUT+
4	TXCLKOUT-
5	TXOUT2+
6	TXOUT2-
7	TXOUT1+
8	TXOUT1-
9	TXOUT0+
10	TXOUT0-
11	GND
12	TxD
13	RxD
14	DC IN
15	DC IN
16	DC IN
17	DC IN
18	DC IN
19	GND
20	GND
21	TXOUT7+
22	TXOUT7-
23	TXOUT6+
24	TXOUT6-
25	NC
26	NC
27	TXOUT5+
28	TXOUT5-
29	TXOUT4+
30	TXOUT4-

J302	
1	GND
2	TxD
3	RxD
4	NC
5	GND
6	NC
7	GND
8	ADKEY
9	NC
10	D/N-IN
11	NC
12	MD-OUT
13	485-DIR
14	NC
15	GND
16	+5V
17	GND
18	CVBS-OUT
19	GND
20	DC IN
21	DC IN
22	DC IN
23	DC IN
24	DC IN

Ref 05002HR-24J05(YEONHO)

J303	
1	GND
2	CVBS-OUT

Ref 12505WR-02(YEONHO)

Ref USL00-30L-C(KEL Cop.)



Infinite Pixels Electronic USA Inc.
11500 S. Eastern Ave. Suite 150 Henderson NV 89052
www.ipxusa.com / sales@ipxusa.com